

WASHING MACHINE USER'S MANUAL

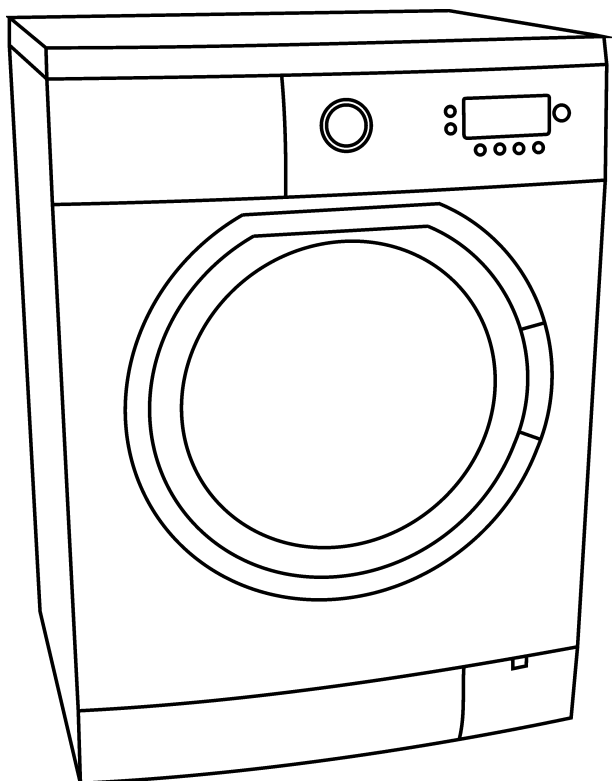

**BEFORE USING THE WASHING MACHINE, YOU SHOULD
CERTAINLY READ THE INFORMATION IN USER'S MANUAL.**

CONTENTS

CHAPTER-1: TECHNICAL SPECIFICATIONS	3
CHAPTER-2: BEFORE USING WASHING MACHINE	5
• Safety warnings.....	5
• Recommendations.....	6
CHAPTER-3: SETTING UP	7
• Removing transport safety screws.....	7
• Adjusting adjustable stays.....	9
• Electrical connection.....	10
• Water inlet connection.....	10
• Water discharge connection.....	11
CHAPTER-4: PRELIMINARY PREPARATION FOR LAUNDERING	12
CHAPTER-5: CONTROL PANEL	16
• Detergent drawer.....	17
• Programme knob.....	18
• Electronic display.....	19
CHAPTER-6: OPERATING YOUR MACHINE	20
• Selecting programme.....	20
• Auxiliary functions.....	20
• Starting the programme.....	29
• Adding/Removing laundry.....	30
• Child lock.....	31
• Cancelling programme.....	32
• Finishing programme.....	33
CHAPTER-7: ELECTRONIC DISPLAY WARNING SYMBOLS	34
• Warning of water cut-off/low mains water pressure.....	34
• Warning of clogged pump filter.....	35
CHAPTER-8: MAINTENANCE AND CLEANING OF YOUR MACHINE	36
CHAPTER-9: PRACTICAL INFORMATION	41
CHAPTER-10: TROUBLESHOOTING	43
CHAPTER-11: AUTOMATIC FAULT WARNINGS AND WHAT TO BE DONE	48
CHAPTER-12: DESCRIBING AND SAVING ENERGY	50

CHAPTER -1: TECHNICAL SPECIFICATIONS

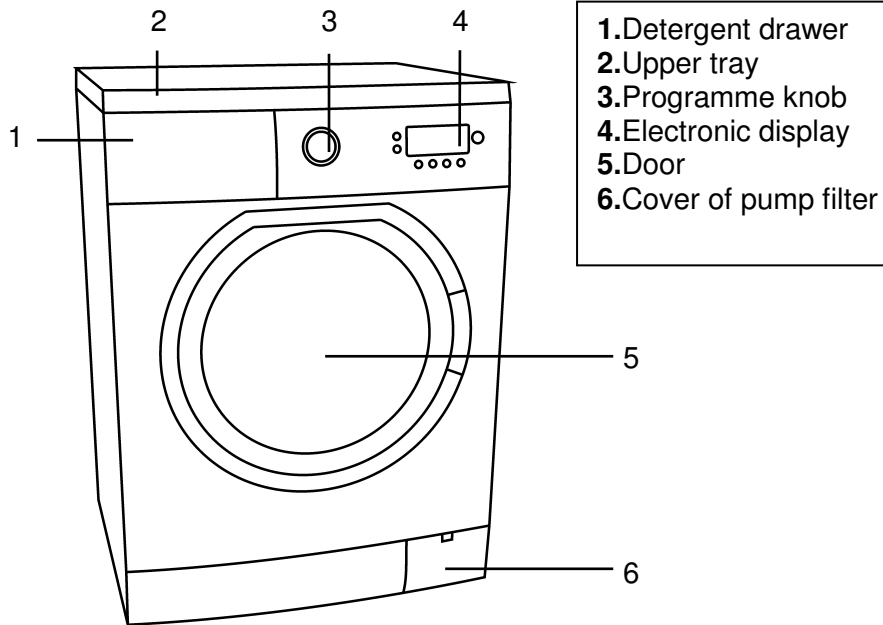

- 1. Detergent drawer
- 2. Upper tray
- 3. Programme knob
- 4. Electronic display
- 5. Door
- 6. Cover of pump filter

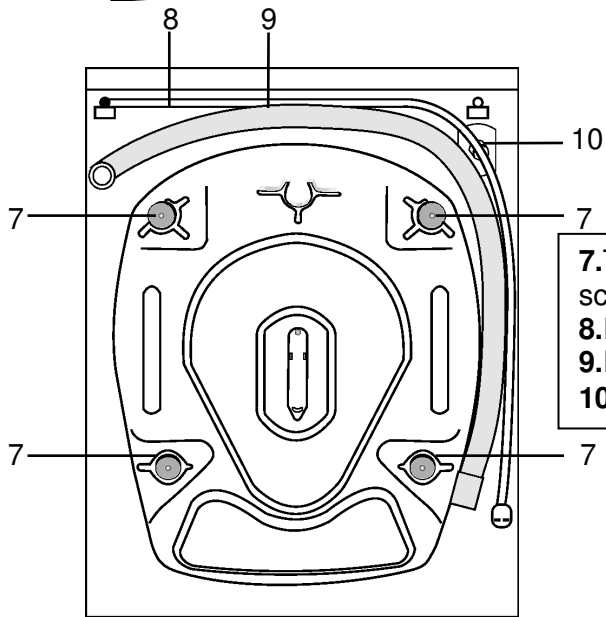

- 7. Transport safety screw
- 8. Power cable
- 9. Discharging hose
- 10. Water inlet valve

CHAPTER -1: TECHNICAL SPECIFICATIONS

Operating voltage / frequency (V/Hz)	(220-240) V ~/50Hz
Total current (A)	10
Water pressure (Mpa)	Maximum: 1 Mpa Minimum: 0.1 MPa
Total power (W)	2200
Maximum dry laundry capacity (kg)	8
Wringing revolution (rev / min)	1000
Programme number	15
Dimensions (Height x Width x Depth) (mm)	845 x 597 x 582

CHAPTER -2: BEFORE USING YOUR WASHING MACHINE SAFETY WARNINGS

SAFETY WARNINGS

- Do not use multiple receptacles or extension cord.
- Do not plug in damaged or torn plugs.
- In case of a breakdown of power cable, contact the nearest authorized service for replacing it.
- Never pull the cable when unplugging. Grab the plug when unplugging.
- Do not plug-in or out the plug from the receptacle with wet hands to prevent electric shock.
- Never touch the machine with your wet, damped hand or foot.
- Never open the detergent compartment when the appliance is running.
- Never force the door to open when the washing machine is running.
- Do not touch discharging hose and water during discharging as the appliance may reach high temperatures when running.
- In case of any breakdown, unplug the appliance firstly and then turn the water faucet off. Do not attempt to repair by yourself and consult authorized service.
- Remember that packaging materials of your machine may be dangerous for children. Keep the packaging materials in a place where children cannot reach or dispose of them as to wasting instructions.
- Do not allow your children play with the washing machine which is an electrically-driven appliance.
- Keep your pets away from your machine.
- Your machine should only be used by adults in line with the information provided in this user's manual.
- Your machine is designed to be used domestically. Commercial use will cause your warranty to be cancelled.
- Anyone's intervention to your machine except authorized services in anyway will cause your warranty to be invalid.
- Ideal operating temperature of your machine is 15-25°C.
- Do not deploy your machine on carpet and suchlike grounds that shall block ventilation of the base.
- Do not keep inflammable liquids near your machine.

CHAPTER -2: BEFORE USING YOUR WASHING MACHINE SAFETY WARNINGS / RECOMMENDATIONS

- You should absolutely remove the transport screws of your machine before the first usage. Faults occurring in the machines operated with transport screw fitted shall be out of scope of warranty.
- Do not put discharging hose of your machine in a vessel, bucket or sink.
- Your machine is out of warranty against faults caused by any kind of external factors (spate, pesticides, fire, etc.).
- The appliance is not intended for use by people (including children) with reduced physical, sensor or mental capabilities, or lack of experience and knowledge, unless they have been given supervision or instruction concerning use of the appliance by a person responsible for their safety. Children should be supervised to ensure that they don't play with the appliance.

RECOMMENDATIONS

- Before beginning to use your washing machine, ask for free-of-charge help about installing, commissioning and using your washing machine by calling the nearest authorized service.
- **It is recommended to perform the first washing operation in 95° White Cotton programme and without laundry by inserting ½ scale of detergent in 2nd compartment of the detergent drawer.**
- As detergent or softener exposed to air for a long time may cause residues, put your detergent or softener in the detergent drawer in the beginning of each washing.
- It is recommended that you wash only extremely dirty laundries in prewashing programme.
- The amount of laundries you put in your washing machine shall not exceed the maximum amount indicated. By this way, your machine shall run in saving mode.
- It will help that inner side of your machine will remain dry and no unpleasant smell will occur provided that you unplug the appliance, turn off the water inlet faucet and leave the door open or spaced-out if you will not use your machine for a long time.
- Some water may be left in your machine due to experiments and tests carried out during production. This will not damage your machine.

CHAPTER -3: SETTING UP REMOVING TRANSPORT SAFETY SCREWS

Before operating your washing machine, you should certainly remove the transport safety screw on the rear side of the machine.

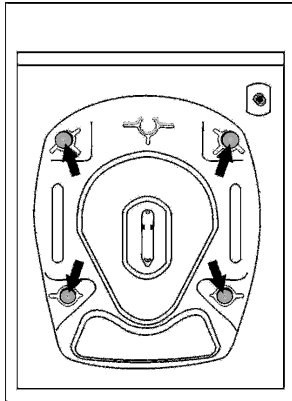

For this reason, transport safety screws shall be loosened by being rotated in counter-clockwise using an appropriate wrench.

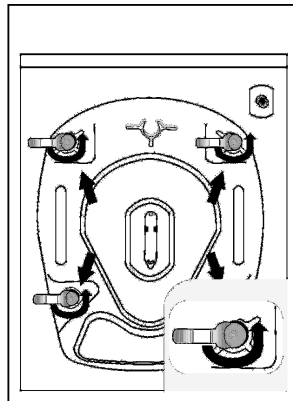

CHAPTER -3: SETTING UP REMOVING TRANSPORT SAFETY SCREWS

Transport screws shall be removed by pulling out.

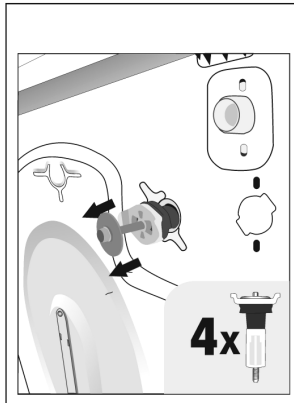

Fit the plastic transport screw taps delivered in accessories bag to the places where transport screws have been removed.

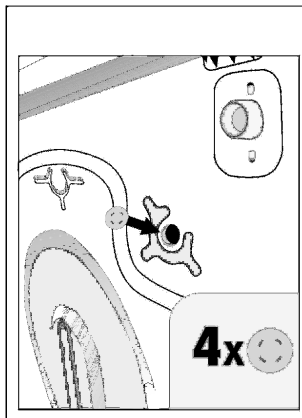

The transport safety screws should be stored to be used in case of a transportation.

You should absolutely remove the transport screws of your machine before the first usage. Faults occurring in the machines operated with transport screw fitted shall be out of scope of warranty.

CHAPTER -3: SETTING UP ADJUSTING ADJUSTABLE STAYS

- Do not install your machine on a carpet or suchlike grounds.
- To ensure silent and vibration-free operation of your machine, it should be deployed on a non-sliding and firm ground.
- Loosen the plastic adjustment nut.

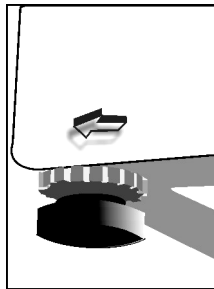

- Adjust the stays upward and downward by rotating them.

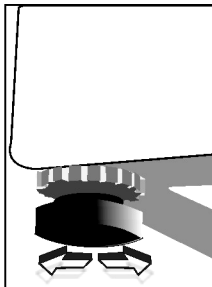

- After maintaining the balance, compress the plastic adjustment nut upward again.
- Never put cardboard, wood or suchlike materials under your machine if you are intending to stabilize the distortions on the ground.
- When cleaning the ground, on which your machine rests, be careful not to disorder stays stabilization.

CHAPTER -3: SETTING UP ELECTRICAL CONNECTION / WATER INLET CONNECTION

Electrical connection

- Your washing machine is set to 220-240V and 50Hz.
- Mains cord of your washing machine is equipped with a specific grounded plug. This plug should always be inserted to a grounded receptacle of 10 amperes. Fuse current value of the power line connected to this plug should also be 10 amperes. If you don't have such a receptacle and fuse confirming with this, please have it done by a qualified electrician.
- **We do not take the responsibility of the damages that occur due to ungrounded usage.**
- Operating your machine under low voltage will cause the life cycle of your machine to be reduced and its performance to be restricted.

Water inlet connection

- Your machine may have either a single inlet (cold) or double water inlets (cold/hot) based on its specifications. White-capped hose should be connected to cold water inlet and red-capped hose to hot water inlet (applicable for machines with double water inlets).
- To eliminate water leakages in points of contact, 1 or 2 nuts are provided in the hose package (applicable for machines with double water inlets). Fit these nuts to the ends of new water inlet hoses on the side of faucet.
- Connect the white-elbow end of the water inlet hoses to the white-filtered water inlet valve on the rear side of the machine and the red-elbow end to red-filtered one (applicable for machines with double water inlets). Tighten plastic parts of the junctions using your hand. In uncertain conditions, have the connection works be done by a qualified plumber.
- Flow of water with pressure of 0.1-1 Mpa will allow your machine to operate more efficiently (0.1 Mpa pressure means that more than 8 litres of water will flow through a fully-tapped faucet per one minute).
- Ensure that points of contact do not leak by tapping the faucet completely after carrying making the connections.
- Ensure that new water inlet hoses are not folded, broken, crushed or their dimensions are not altered.
- Mount new water inlet hoses to a $\frac{3}{4}$ " , threaded faucet.
- If your machine has double hot water inlets, the temperature of hot water inlet should be maximum 70°C.

CHAPTER -3: SETTING UP WATER INLET CONNECTION / WATER DISCHARGE CONNECTION

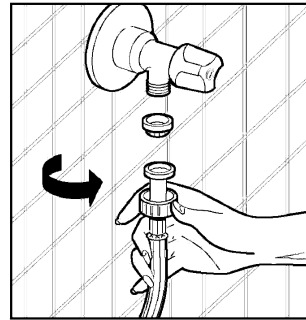
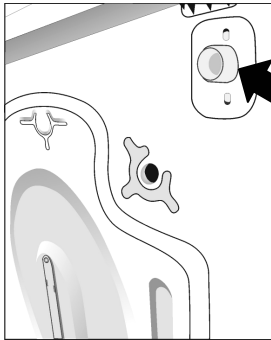

Water discharge connection

- Ensure that water discharge hose is not folded, twisted, crushed or elongated.
- Water discharge hose can be fitted minimum 60 cm and maximum 100 cm above the ground.
- The end of water discharge hose can be fitted to a specific apparatus directly attached to dirty water discharge hole or outlet joint of the basin elbow.
- Never attempt to extend the water discharge hose by jointing.
- Do not put discharging hose of your machine in a vessel, bucket or sink.

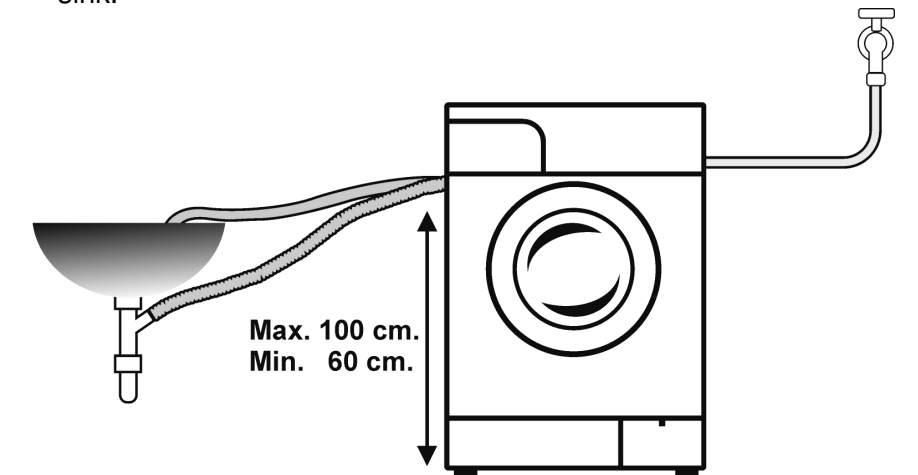







CHAPTER-4: PRELIMINARY PREPARATION FOR LAUNDERING SEPARATING LAUNDRIES















- Separate your laundries according to their types (cotton, synthetic, sensitive, woollen, etc.), their temperatures (cold, 30°, 40°, 60°, 90°) and degree of contamination (slightly stained, stained, highly stained).
- Never wash your coloured and white laundries together.
- Wash your coloured laundries separately in the first washing as they may bleed.
- Ensure that there are no metallic materials on your laundries or in the pockets; if so, take them up.

WARNING: Faults that will emerge in case of penetration of foreign substances into your machine are not included within the scope of warranty.

- Remove the metallic or plastic hooks of tulle curtains or curtains or place them in a washing net or bag and then muzzle them.
- Unzip and button up your laundries.
- Reverse textiles such as pants, knitwear, t-shirt and sweat suit.
- Wash socks, handkerchief and suchlike small laundries in a washing net.

		
Normal washing	Maximum washing temperature is 90°C	Maximum washing temperature is 60°C
		
Maximum washing temperature is 30°C	Hand washing	No washing

CHAPTER-4: PRELIMINARY PREPARATION FOR LAUNDERING SEPARATING LAUNDRIES

		
Whitening available	No whitening	Ironing temperature is maximum 110°C
		
Ironing temperature is maximum 150°C	Ironing temperature is maximum 200°C	No ironing
		
Dry cleaning available	No dry cleaning	Leave on a flat place
		
Hang when wet	Dry by hanging	Drying by twirling is not allowed
		
Dry cleaning in gas oil, pure alcohol and R113 is allowed	Perchloroethylene R11, R113, Petroleum	Perchlorinethylene R11, R113, Gas oil

CHAPTER-4: PRELIMINARY PREPARATION FOR LAUNDERING PUTTING LAUNDRIES IN THE MACHINE

- Open the door of your machine.
- Spread your laundries in your machine.
Note: Maximum loading capacity may vary based on the laundry type you will wash, degree of contamination and the programme you have chosen. Do not exceed maximum dry loading capacity indicated in the programme table for washing programmes.

You can take the following table of weights as an example.

LAUNDRY TYPE	WEIGHT (gr)
Towel	200
Linen	500
Bathrobe	1200
Quilt cover	700
Pillow slip	200
Underwear	100
Tablecloth	250

- Put the laundries separately.
- Ensure that no laundry is stuck between the cover and bellow seal when closing the door of your machine.
- Push the door of your machine until hearing the locking sound to close it.
- Close the door of your machine properly, otherwise your machine will not start the washing operation.

CHAPTER-4: PRELIMINARY PREPARATION FOR LAUNDERING ADDING DETERGENT INTO MACHINE

The amount of detergent you will put in your machine will depend on the following criteria:

- Your detergent utilization will be based on the degree of contamination of your laundries. Do not prewash your less stained laundries and put your slight amount of detergent in the 2nd compartment of the detergent drawer.
- For your much stained laundries, select a programme including prewashing, and put $\frac{1}{4}$ of the detergent you will put in the detergent drawer in the 1st compartment of the detergent drawer while putting the remaining $\frac{3}{4}$ of it into 2nd compartment.
- Use detergents produced for automatic washing machine in your machine. The amount of detergent you will use for your laundries is printed on the detergent package.
- The higher the degree of hardness of the water the more detergent you will use.
- The amount of the detergent you will use will increase as the amount of your laundries increase.
- Put the softener in the softener compartment in the detergent drawer. Do not exceed the MAX level. Otherwise, softener will flow into washing water through flushing.
- Softeners with high density are required to be thinned to a degree before being put in the drawer. Because high-density softener will clog the flush and avoid the flow of the softener.
- You can use your liquid detergents in all programs without prewashing. For this, fit liquid detergent level plate in the accessories bag into 2nd compartment of the detergent drawer and set the amount of liquid detergent according to the levels on this plate. Remember to detach the liquid detergent plate.

CHAPTER 5: CONTROL PANEL

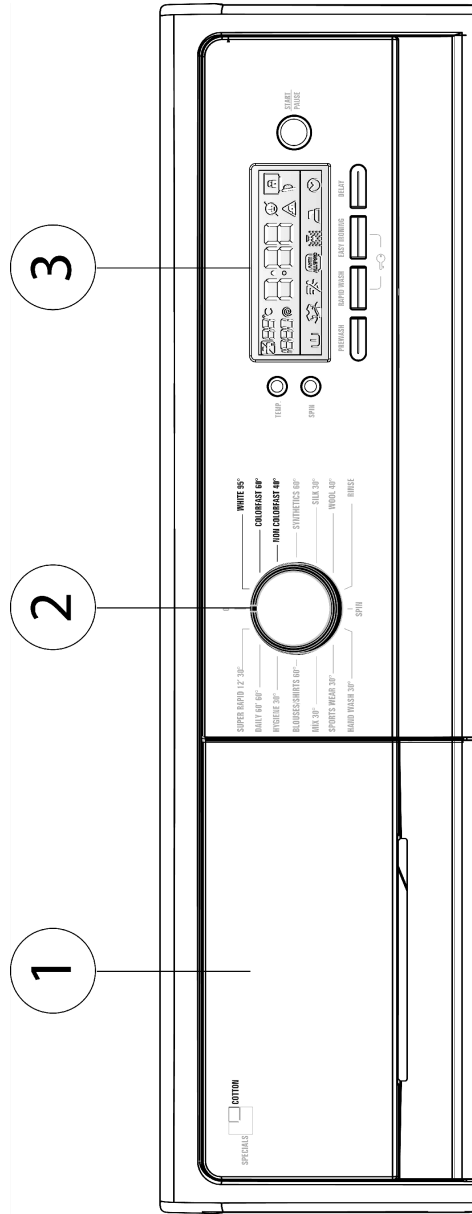

- 1-Detergent drawer
- 2-Programme knob
- 3-Electronic display and auxiliary functions

CHAPTER 5: CONTROL PANEL DETERGENT DRAWER

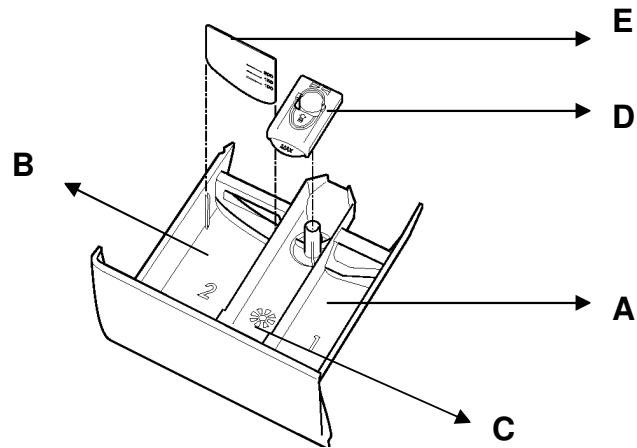

- A. Prewashing compartment
- B. Main washing compartment
- C. Softener compartment
- D. Siphon cover
- E. Liquid level detergent plate

CHAPTER 5: CONTROL PANEL PROGRAMME KNOB

You may select the programme you like to wash your laundries through programme knob. You may set the programme selection operation by rotating the programme knob in both direction. Ensure that the programme knob is exactly on the programme you want to select.

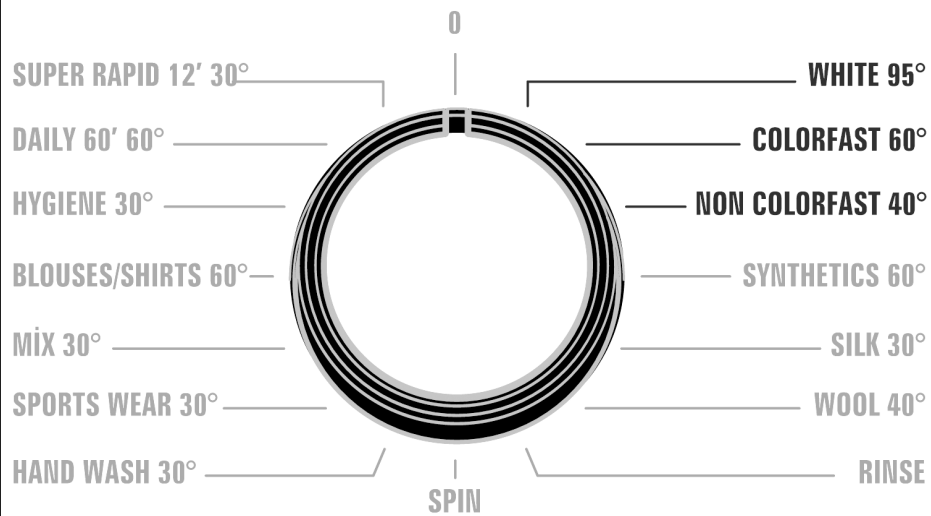

CHAPTER 5: CONTROL PANEL ELECTRONIC DISPLAY

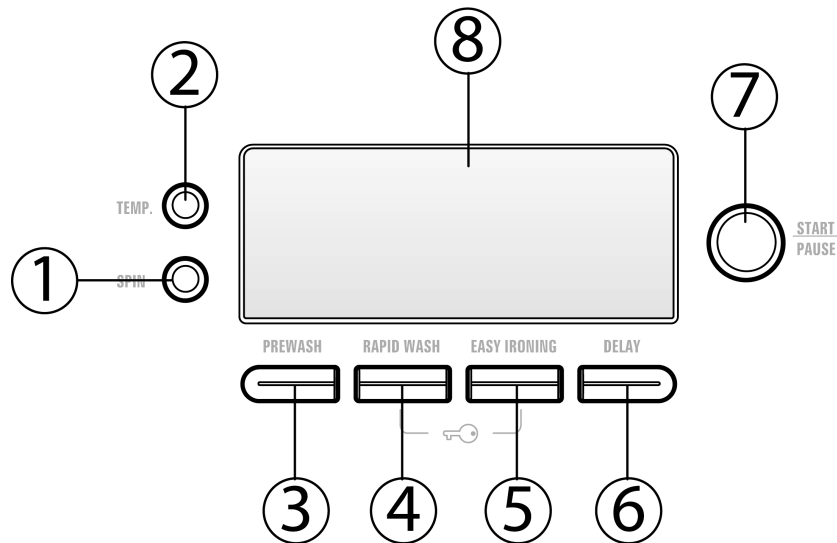

- 1-Adjusting button for revolution speed
- 2-Adjusting button for temperature of washing water
- 3-Auxiliary function prewash
- 4-Auxiliary function for rapid wash
- 5-Auxiliary function for easy ironing
- 6-Auxiliary function for delay timer
- 7-Start/Pause button
- 8-Electronic display

On the electronic display, you may view washing water temperature, wringing revolution speed of your machine, the amount time your machine will continue washing, the auxiliary functions you have selected and whether the door of your machine is locked or not. Furthermore, electronic display will warn you by means of fault symbols on the display when a fault occurs on your machine and notify you of the completion of the washing programme by revealing expression of "END" on the display as soon as the washing programme you have selected has finished as well.

CHAPTER 6: OPERATING YOUR MACHINE

- Plug your machine in.
- Open the water faucet.
- Open the machine door.
- Spread your laundries in your machine.
- Push the door of your machine until hearing the locking sound to close it.
- Put detergent and softener in the detergent drawer.

First washing operation

Some water may be left in your machine due to experiments and tests carried out during production. To dispose of this water, it is recommended to perform the first washing operation in 1st programme and without laundry by inserting ½ scale of detergent in 2nd compartment of the detergent drawer.

Selecting programme

Select the convenient programme for your laundries on the programme table.

Auxiliary functions

Before starting the programme, you can optionally select an auxiliary function.

- Press on the button of auxiliary function you like to select.
- If auxiliary function symbol on electronic display flashes continuously, the auxiliary function you have selected will be activated.
- If auxiliary function symbol on electronic display blinks, the auxiliary function you have selected will not be activated.

Reason for non-activation:

- The auxiliary function you want to use in the washing programme you have selected is not applicable.
- Your machine has passed over the stage, during which the auxiliary function you like to select would be implemented.
- It is not compatible with an auxiliary function you have selected previously.

CHAPTER 6: OPERATING YOUR MACHINE

Half-load detection system

Your machine features a half-load detection system. In case you put approximately half or less amount of laundries of maximum laundry capacity in your machine, your machine will run so as to save washing time, water consumption and energy in some programmes (White cotton 95°, Colorfast cotton 60°, Non colorfast cotton 40°). When half-load function is active, the machine can complete the programme you have set in a shorter time.

Twinjet system

Detergent water in your machine will be circulated with 2 water injection mechanisms and a mixing system via twinjet system. Circulated detergent water will be injected over your laundries, which allows a better washing performance.

Twinjet system will help you wash higher amount of laundries in a shorter time with a better washing performance, guaranteeing less energy and water consumption.



CHAPTER 6: OPERATING YOUR MACHINE PROGRAM TABLE					
PROGRAMME	TEMPERATURE (°C)	PROGRAMME DURATION (MIN.)	DETERGENT COMPARTMENT	MAXIMUM AMOUNT OF DRY LAUNDRY (kg)	LAUNDRY TYPE
1-WHITE COTTON	95	190	2	8	Very dirty cotton and flax textiles. (Underwears, linen, tablecloth, towel (maximum 4 kg), bedclothes, etc.
2-COLORFAST COTTON	60	180	2	8	Dirty cotton and flax textiles. (Underwears, linen, tablecloth, towel (maximum 4 kg), bedclothes, etc.
3-NON COLORFAST COTTON	40	166	2	8	Dirty colour and flax textiles.
4-SYNTHETICS	60	101	2	3,5	Very dirty synthetic or synthetic-mixed textiles. (Nylon socks, shirts, blouses, synthetic-including trousers etc.)
5-SILK	30	91	2	2,5	Less dirty silk-mixed laundries with machine wash labels.
6-WOOL	40	78	2	2,5	Woollen laundries with machine wash labels.
7-RINSE	-	37	-	8	If you want to additionally rinse your laundries upon completion of washing operation, you may use this programme for any kind of laundries.
8-SPIN	-	15	-	8	If you want to additionally wring your laundries upon completion of washing operation, you may use this programme for any kind of laundries.
9-HAND WASH	30	90	2	2,5	Sensitive and woollen laundries with non-machine wash label recommended to be washed by hand.
10-SPORTS WEAR	30	74	2	3,5	Sportswear.
11-MIX WASH	30	103	2	3,5	Dirty cotton, synthetic, colour and flax textiles can be washed together.
12-SHIRTS/ BLOUSES	60	119	2	5	Dirty cotton, synthetic and synthetic-mixed shirts and blouses can be washed together.
13-HYGIENE	30	182	2	5	You can use this programme which eliminates bacteria on your laundries at a low temperature such as 30 °C for less dirty colour, flax textiles and for baby clothes.
14-DAILY 60 min.	60	60	2	4	You can wash your dirty cotton, colour and flax textiles at 60 °C in 60 minutes.
15-SUPER RAPID 12 min.	30	12	2	2	You can wash your dirty cotton, colour and flax textiles in 12 minutes that is a short period. Note: As the washing period is short, less amount of detergent is required to be used compared to other programmes. The programme period will increase if your machine detects instable loading. You can open the door of your machine 2 minutes after the completion of washing operation. (The duration of 2 minutes required to open the door of your machine is not included in the washing period.)

CHAPTER 6: OPERATING YOUR MACHINE AUXILIARY FUNCTIONS

1-Revolution speed selection and auxiliary function of soaking

You can set the wringing revolution for your laundries via revolution speed setting button.

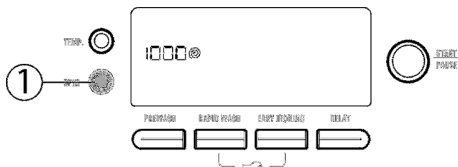

When you select a new programme, the maximum wringing revolution speed of the programme you have selected will be viewed on the display of revolution speed.

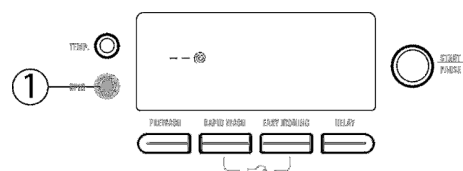

You can gradually reduce the revolution speed between cancel wringing (--) options through the maximum wringing revolution of the programme selected by pressing revolution speed setting button.

If you have skipped the wringing revolution you want to set, you can re-switch to the revolution by keeping the revolution setting button pressed.

If you will not unload your laundries upon completion of the programme and you want them not wrinkle in your machine, you can use the auxiliary function of soaking.

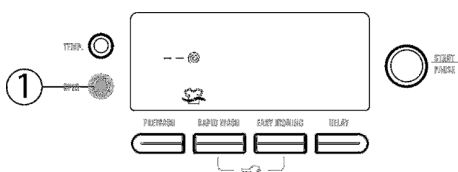

In programmes where auxiliary function of soaking is applicable, it may be activated by pressing on revolution speed setting button once more pursuant to stage of cancel wringing (--). You can conceive that it is active when symbol  flashes on electronic display.

CHAPTER 6: OPERATING YOUR MACHINE AUXILIARY FUNCTIONS

If this function is selected, your laundries will be soaked in the latest rinsing water. When your machine soaks your laundries in the latest rinsing water, symbol  will blink on electronic display.

If you want to take your laundries out, press on “Start / Pause” button. Your machine will empty the water in it and finish the programme without wringing.

If you like to wring your laundries:

- a) You can select wringing revolution by using the revolution speed setting button when your machine is soaking your laundries in the latest rinsing water. If you want to take your laundries out, press on “Start / Pause” button. Your machine will empty the water in it and finish the programme after wringing your laundries through the wringing revolution you have selected.
- b) Switch the programme knob to 0. Select wringing programme on programme knob. You can optionally reduce the revolution speed. You can start your machine by pressing on Start/Pause button. Your machine will finish the programme after wringing your laundries in the wringing revolution you have selected.

CHAPTER 6: OPERATING YOUR MACHINE AUXILIARY FUNCTIONS

2-Washing water temperature selection

You can select the washing water temperature with the washing water temperature adjustment button.

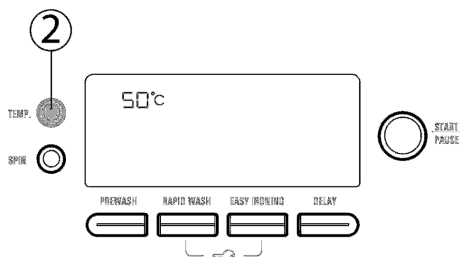

Whenever you select a new programme, the maximum washing water temperature is shown on the washing water temperature display.

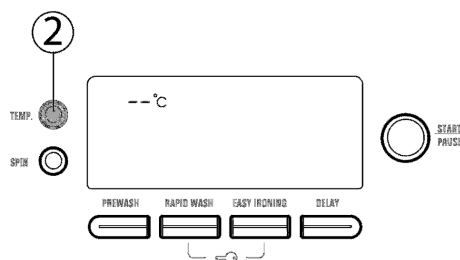

You can gradually decrease the washing water temperature between the maximum temperature and cold washing (--) by pressing washing water temperature adjustment button.

If you have missed the washing water temperature you wanted, you can return to the intended temperature by continuously pressing the washing water temperature adjustment button.

CHAPTER 6: OPERATING YOUR MACHINE AUXILIARY FUNCTIONS

3-Auxiliary function prewash

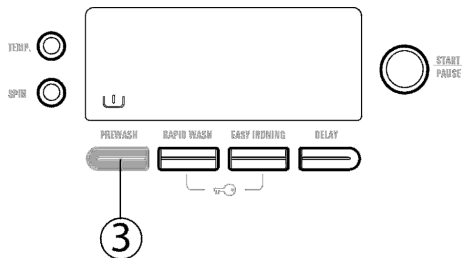

You can expose your very dirty laundries to prewashing operation prior to main washing by using this auxiliary function. When using this function, you should put detergent in front washing compartment of the detergent drawer.

4-Auxiliary function for rapid wash

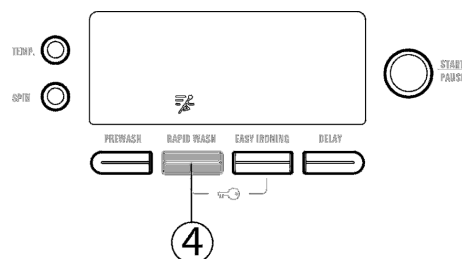

This auxiliary function will enable the washing duration of your laundries that are not very dirty to be shortened. In case you put half of or less than half of the laundry capacity of the washing programme you have selected in your machine, your machine will detect this event thanks to automatic

Half-load detection system, and the programme you have selected will wash your laundries in a shorter time to consume less energy and water. If your machine detects half load, symbol  will automatically flash on electronic display. To cancel it, pressing on the auxiliary function of quick washing for once will be enough. However, selection of auxiliary function of quick washing is not possible in course of the same washing operation.

5-Auxiliary function for easy ironing

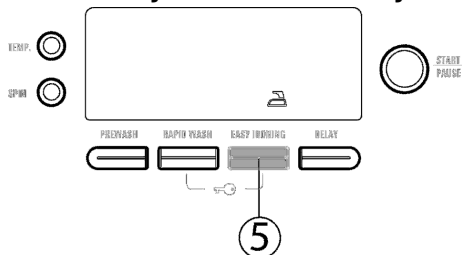

You can enable your laundries to be taken out less wrinkled as the washing operation is completed by employing this auxiliary function.

CHAPTER 6: OPERATING YOUR MACHINE AUXILIARY FUNCTIONS

6-Auxiliary function for delay timer

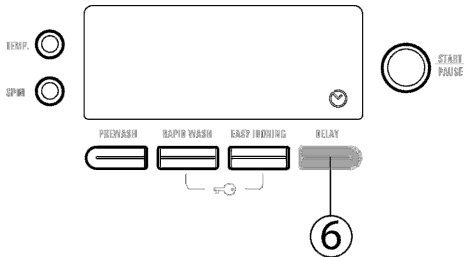

By using this auxiliary function, you can let your machine start washing after half an hour to 23 hours.

To use auxiliary function of delay timer:

- Press time delay button once.
- Expression of "0.5h" will appear on the display.
- Press on time delay button until the time, on which you want washing operation to be started.
- To activate the time delay you have selected in the programme, you may press on any auxiliary function button you like except "Start/Pause" button.

Intervals of delay timer is half an hour for the first 2 hours, 1 hour for 3 hours to 23 hours.

If you have skipped the time delay you want to set, you can go back to the time desired by keeping pressed on delay timer button.

If you want to cancel the delay timer, you are required to press the delay timer button once.

To run delay timer function, your machine is required to be operated by pressing on Start/Pause button. As soon as you start your machine, the count down process will start on the electronic display based on the delay period you have selected.

CHAPTER 6: OPERATING YOUR MACHINE AUXILIARY FUNCTIONS

7-Anti-Allergic auxiliary function

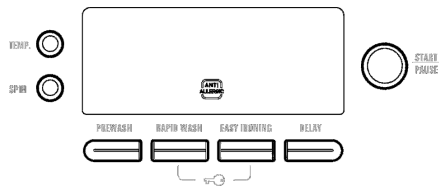

In the programmes where this auxiliary function is active, your machine will perform an extra rinsing operation on your laundries prior to latest rinsing operation.

Note: Anti-Allergic auxiliary function is selected automatically only in Hygiene programme.

CHAPTER 6: OPERATING YOUR MACHINE STARTING THE PROGRAMME

Start/Pause button

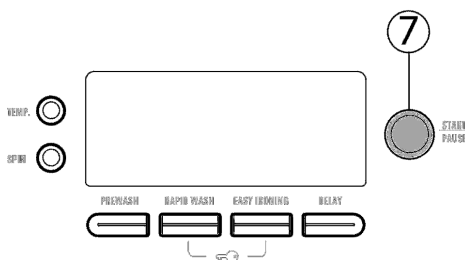

By pressing on Start/Pause button, you may start the programme you have selected, suspend a running programme. If you switch your machine to pause mode, electronic display will blink.

When you start your machine, the following symbols for the programmes you have selected will be available on electronic display.

- Temperature of washing water
- Revolution speed
- If you have selected, symbols of auxiliary functions
- Programme ending time or programme delay time based on your selection
- Symbol of open or locked door

Note: Symbol for open door flashing on electronic display will go off and symbol for locked door will flash approximately 1 minute after you start your machine by pressing Start/pause button.



Open door



Locked door

CHAPTER 6: OPERATING YOUR MACHINE ADDING/REMOVING LAUNDRY

Laundry adding to / removing from the machine

If you want to add or remove laundries when your machine is running:

- Switch your machine to pause mode by pressing on Start/Pause button.

- After a while, if you realize that symbol  moves over electronic display, this means that the door of your machine will be convenient

for opening. When you see symbol  on electronic display, you can either add or remove laundries after opening the machine door.

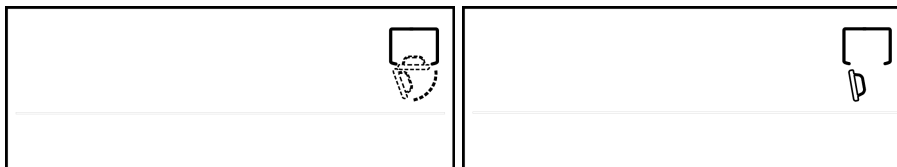

Note: If symbol  blinks on the electronic display, it means that your machine cannot carry out the operation of laundry adding or removing as your machine has passed the steps in question.

- Upon completion of laundry adding or removing function, close the door of your machine and press on Start/Pause button.

- Your machine will continue to wash after locking the door of your machine.

- Symbol  will flash on electronic display.

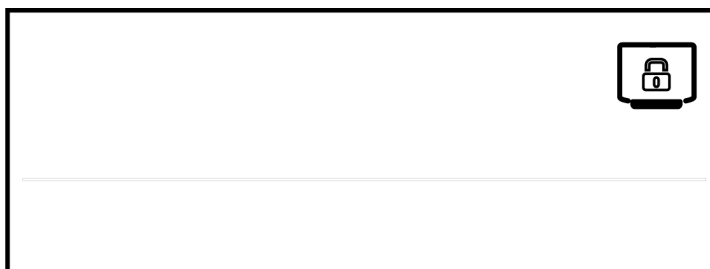



CHAPTER 6: OPERATING YOUR MACHINE

CHILD LOCK

Child lock

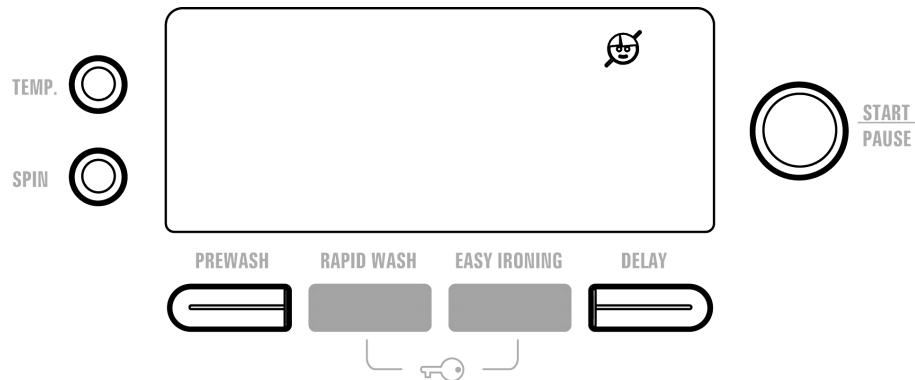
To avoid programme flow from being affected if programme knobs are pressed or programme knob is turned when performing washing operation in your machine, child lock is available. Child lock will be activated in case pressed on both auxiliary functions of quick washing and wrinkle removing at the same time in excess of 3 seconds.



Symbol  will flash on the electronic display when activated.

If pressed any button while child lock is active, symbol  will blink on the electronic display.

When any of the programmes is running and child lock is active, if another programme is selected after programme knob is switched to 0 position, the programme already running will resume.

To deactivate it, it will be sufficient to press on the same buttons for more than 3 seconds. When child lock is deactivated, symbol  on the electronic display will go off.

CHAPTER 6: OPERATING YOUR MACHINE CANCELLING PROGRAMME

Cancelling programme

If you want to cancel any programme running:

- Switch the programme knob to 0.
- Your machine will stop the washing operation and the programme will be cancelled.
- To get rid of the water accumulated in the machine switch the programme knob to any programme.
- Your machine will perform the necessary discharge operation and cancel the programme.
- You can run your machine by selecting a new programme.

CHAPTER 6: OPERATING YOUR MACHINE FINISHING PROGRAMME

Finishing programme

- Your machine will stop by itself as soon as the programme you have selected finishes.
- Expression of "END" will flash on the electronic display.

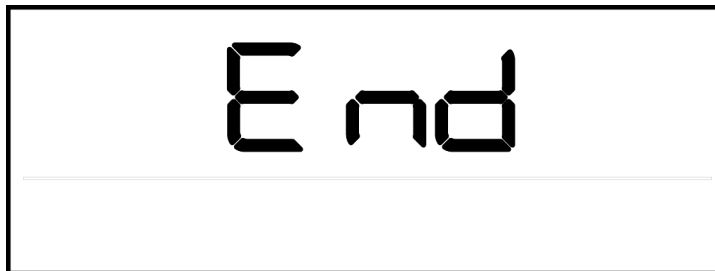

Note: Within 2 minutes after the programme has finished, your machine will extinguish the electronic display to save energy. It will re-flash when pressed on a button of any auxiliary function.

- If you see that the symbol indicating that the door can be opened flashes on the electronic display, you can open the door of your machine and remove the laundries.



- Leave the door of your machine open to allow the inner part of your machine to dry after removing your laundries.
- Switch the programme knob to 0.
- Unplug your machine.
- Turn the water faucet off.

CHAPTER -7: ELECTRONIC DISPLAY WARNING SYMBOLS WARNING OF WATER CUT-OFF / LOW MAINS WATER PRESSURE

If symbol  flashes on the electronic display:

- Water faucet may be closed. Check.
- Mains water may be cut-off. Check. If so, switch the programme knob to position 0. You can select a programme and run your machine after the mains water is supplied.
- Mains water pressure may be low. Check.
- Water inlet hose may be twisted. Check.
- Water inlet hose may be clogged. Clean water inlet hose filters. (*)
- Valve inlet filter may be clogged. Clean the valve inlet filters. (*)

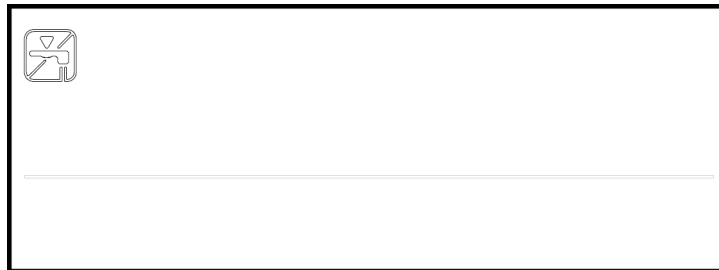

(*) See the chapter regarding maintenance and cleaning of your machine.

CHAPTER -7: ELECTRONIC DISPLAY WARNING SYMBOLS WARNING OF CLOGGED PUMP FILTER

If symbol  flashes on the electronic display:

- Pump filter may be clogged. Clean the pump filter. (*)
- Discharging hose may be clogged or twisted. Check the discharging hose.

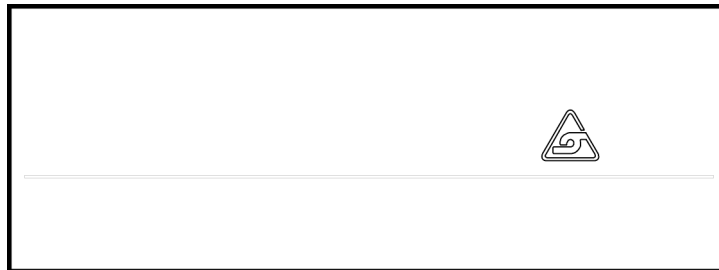

(*) See the chapter regarding maintenance and cleaning of your machine.

CHAPTER -8: MAINTENANCE AND CLEANING OF YOUR MACHINE



- Unplug your machine.
- Turn the water faucet off.

WATER INLET FILTERS

Filters to avoid dirt and foreign substances in the water from penetrating into the machine are available both on the side of faucet and on the ends of water valves along the water inlet hose of your machine. If your machine cannot intake sufficient amount of water despite water faucet being open, these filters should be cleaned.

- Detach the water inlet hoses.
- Remove the filters on water inlet valves using pliers and then clean it with a brush in water.
- Disassemble the filters on the side of faucet side of water inlet hoses manually and clean it.
- Having the filters cleaned, you can fit them in the same way reversely.



CAUTION: Filters of water inlet valves may be clogged due to contaminated water faucet or lack of necessary maintenance or valves may be broken down, causing water leaking into your machine continuously. **For these reasons, breakdowns that may arise are out of scope of warranty.**

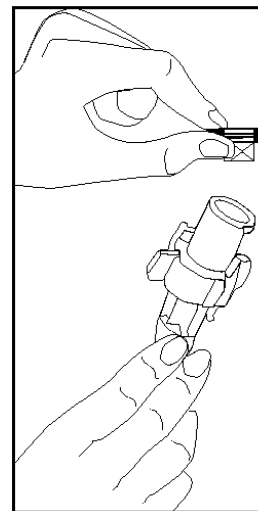
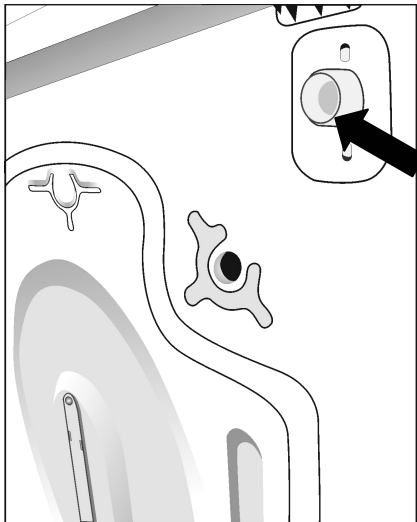

CHAPTER -8: MAINTENANCE AND CLEANING OF YOUR MACHINE / PUMP FILTER

A filter system which avoids threads remaining from your laundries and tiny materials from entering into the pump during water discharging operation carried out by your machine after completing washing so prolonging the lifecycle of your pump is available. It is recommended that you clean your pump filter once in 2 months. To clean pump filter:

- Depress the lug downwardly to uncover the pump section of the toe board and pull it towards yourself and extract it.

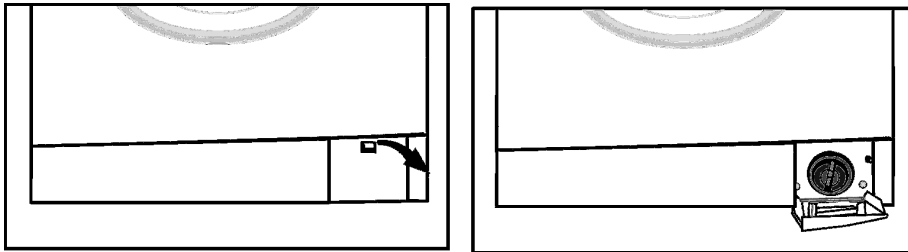

- Before opening the filter cover, settle a vessel in front of the filter cover to prevent the water remained in the machine from flowing on the ground.

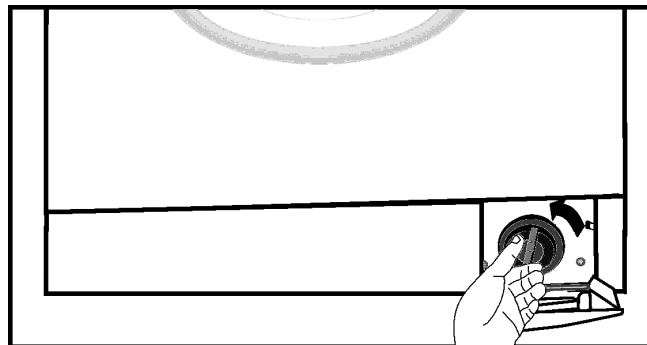

- Loosen the filter cover in counter-clockwise and then empty water.
- Clean the foreign materials in the filter.
- Check whether the pump rotates with your hands.

CHAPTER -8: MAINTENANCE AND CLEANING OF YOUR MACHINE / PUMP FILTER

- After cleaning the filter, fit the filter cover by rotating it in clockwise.
- Fit the pump section of the toe board.
- Remember that water will leak if you do not fit the filter cover properly.
- You can use the pump section of the toe board for discharging slight amount of water remaining in the pump of your machine.



WARNING!

As water in the pump may be hot, wait until it cools down.

CHAPTER -8: MAINTENANCE AND CLEANING OF YOUR MACHINE / DETERGENT DRAWER

Your detergents may deposit residue in detergent drawer and housing of detergent drawer over time. To clean the residue formed, disassemble the detergent drawer in particular periods. To eject the detergent drawer:

- Pull the detergent drawer up to the end

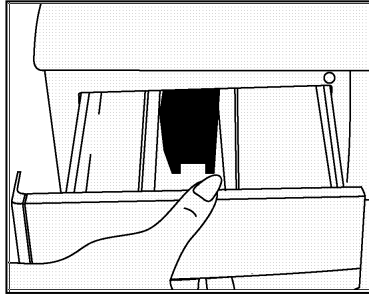

- Keep on pulling by depressing on the flush cover in the detergent drawer already being pulled up to the end and then unsettle the detergent drawer.

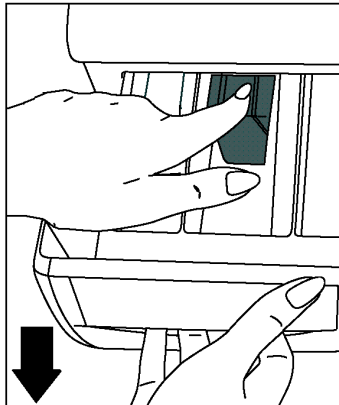

- Flush it using a brush.
- Collect residues in the housing of the detergent drawer without dropping them inside the machine.
- To assemble the detergent drawer after drying it using a towel or dry cloth, resettle the detergent drawer by depressing on the flush cover and fit it by pushing forward.
- **Do not wash your detergent drawer in dishwasher.**

CHAPTER -8: MAINTENANCE AND CLEANING OF YOUR MACHINE / SIPHON PLUG / BODY / DRUM

Siphon plug

Disassemble the detergent drawer. Disassemble the flush stopper and clean the softener residues completely. Refit the flush stopper after cleaning it. Check whether it has settled properly.

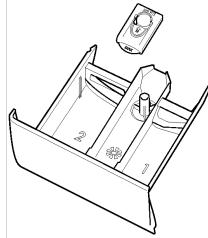

Body

Clean the outer body of your machine with warm water and a non-inflammable cleaning agent that will not abrade the body of your machine. After rinsing with some water, dry it using a soft and dry cloth.

Drum

Do not leave metallic objects such as needles, paper clips, coins, etc. in your machine. These objects will lead to formation of rust stains in the drum. To clean such rust stains, use a non-chlorine cleaning agent and follow the instructions of manufacturers of the cleaning agent. Never use wire wool or similar hard objects for cleaning rust stains.

CHAPTER -9: PRACTICAL INFORMATION



Alcoholic drinks: Spotted area should initially be washed using cold water, and then be wiped with glycerine and water and rinsed with vinegar-mixed water.



Shoe shine: Spot should be rubbed out gently without damaging the cloth and be scrubbed and rinsed with detergent. If not removed, it should be scrubbed using the mixture obtained by adding 1 scale of alcohol (96°) into 2 scales of water, and then be washed with warm water.



Tea and coffee: Stretch the spotted area of your laundry throughout the opening of a vessel, and pour hot water as much as the type of your laundry can resist. In case the type of your laundry permits, wash with bleacher.



Chocolate and cocoa: After submerging you laundries in cold water and rubbing it using soap or detergent, wash it in temperature that fabric type of your laundry can resist. In case oil stain is still visible, wipe with oxygen water (3%).



Tomato paste: After rubbing out the dried substances without damaging your laundry, submerge it in water for 30 minutes, and then scrub and wash it with detergent.



Bouillon-egg: Remove dried spot residues on your laundry, and then wipe it with a sponge or soft cloth submerged in cold water previously. Scrub with detergent, wash with diluted bleacher.



Gres ve yağ lekesi: Firstly, wipe the residues. Scrub the spot with detergent and wash it with warm soapy water.



Mustard: Apply glycerine on spotted area. Scrub with detergent and wash. If spot cannot be removed, wipe with alcohol. (For synthetic and colour fabrics, a mixture of 1 scale of alcohol and 2 scales of water should be used)

CHAPTER -9: PRACTICAL INFORMATION



Blood stain: Submerge your laundries in cold water for 30 minutes. If the stain is not removed, then submerge in a mixture of water and ammoniac (3 spoons of ammoniac in 4 litres of water) for 30 minutes.



Cream, ice cream and milk: Submerge your laundries in cold water and scrub the spotted area with detergent. If the spot is not removed, apply bleacher to the extent suitable for your laundries. (Do not use bleacher for colour laundries.)



Muff: Muff stains should be cleaned as soon as possible. Stain should be washed with detergent water, nevertheless if it cannot be removed, it should be wiped with oxygen water (3%).



Ink: Subject the spotted area to running water and wait until the flow of inked water ends. Then, wipe it with lemon-added water and detergent, and wash it after allowing 5 minutes.



Fruit: Stretch the spotted area of your laundry throughout the opening of a vessel, and pour cold water on it. Do not pour hot water on the spot. Wipe with cold water and apply glycerine. Allow 1-2 hours, wipe with a few drops of white vinegar, and rinse it.



Grass stain: Wipe the stained part with detergent. If type of your cloth permits bleacher using, wash with bleacher. Wipe your woollen laundries with alcohol. (For colour fabrics, a mixture of 1 scale of pure alcohol and 2 scales of water)



Oil paint: Spot should be removed by applying thinner before drying. Then, it should be wiped with detergent and washed.



Burn stain: If your laundry is suitable for applying bleacher, you can add bleacher into washing water. For woollen fabrics, a cloth previously submerged in oxygen water should be covered over the stain, and it should be ironed after putting a dry cloth on this cloth. It should be washed after being rinsed properly.

CHAPTER -10: TROUBLESHOOTING

All repairing operations required for your machine should be carried out by our authorised service. If your machine requires a repair or if you cannot remove the fault by the help of the information provided as follows:

- Unplug your machine.
- Turn the water faucet off.
- Contact the nearest authorised service.

FAULT	POSSIBLE CAUSE	REMOVING METHODS
Your machine does not start.	It is not plugged.	Plug it.
	Fuses out of order.	Replace the fuses.
	Electricity cut-off.	Check mains power.
	Start/pause button not pressed.	Press on start/pause button.
	Programme knob on position 0.	Switch the programme knob to the desired position.
	The machine door not completely closed.	Close the machine door.
Your machine does not intake water.	Your faucet turned off.	Turn your faucet on.
	Water inlet hose may be twisted.	Check water inlet hose.
	Water inlet hose clogged.	Clean water inlet hose filters. (*)
	Valve inlet filter clogged.	Clean the valve inlet filters. (*)
	The machine door not completely closed.	Close the machine door.

(*) See the chapter regarding maintenance and cleaning of your machine.

CHAPTER -10: TROUBLESHOOTING

FAULT	POSSIBLE CAUSE	REMOVING METHODS
Your machine does not discharge water.	Discharging hose clogged or twisted.	Check the discharging hose.
	Pump filter clogged.	Clean the pump filter. (*)
	Laundries settled in the machine non-homogeneously.	Spread your laundries in the machine properly and homogeneously.
Your machine vibrates.	The stays of your machine not adjusted.	Adjust the stays of your machine. (**)
	Safety assembly fitted for transport not disassembled.	Disassemble the safety assembly of your machine. (**)
	Less amount of laundries in the appliance.	This will not block operation of your machine.
	Your machine overloaded with laundries or laundries settled non-homogeneously	Do not put laundries more than the amount recommended and settle the laundries in the machine homogeneously.
	Your machine rests on a hard surface.	Prevent your machine from resting on hard surfaces. When settling your machine, leave 2 cm space between it and wall or hard surfaces.

(*) See the chapter regarding maintenance and cleaning of your machine.

(**) See the chapter regarding installation of your machine.

CHAPTER -10: TROUBLESHOOTING

FAULT	POSSIBLE CAUSE	REMOVING METHODS
Excessive foam is formed in the detergent drawer.	Excessive amount of detergent used.	Press on Start/Pause button. To eliminate foam formation, mix a spoon of softener with half litres of water, and pour the mixture in the detergent drawer. After 5-10 minutes, press on Start/Pause button again. In next washing operation, decide the dose of detergent as required.
	Wrong detergent used..	Use detergents produced only for automatic washing machines in your machine.
Unsatisfactory washing result.	The contamination degree of your laundries does not match the programme you have chosen.	Select the programme appropriate for the contamination degree of your laundries. (see programme table)
	Amount of detergent used insufficient.	Adjust the amount of detergent based on the amount and contamination degree of your laundries.
	Laundries in excess of maximum capacity put in your machine.	Load your machine with laundries, amount of which will not exceed maximum laundry capacity

CHAPTER -10: TROUBLESHOOTING

FAULT	POSSIBLE CAUSE	REMOVING METHODS
Unsatisfactory washing result.	Water being hard. (Dirty, hard, etc.)	Adjust the amount of detergent based on the instruction of detergent manufacturer.
	Laundries distributed in your machine non-homogenously.	Spread your laundries in the machine properly and homogeneously.
As soon as the machine is loaded with water, water discharges.	The end of water discharging hose is too low for the machine.	Set the water discharging hose on appropriate height. (**)
No water appears in the drum during washing.	No fault. Water in the non-visible part of the drum.	-
Laundries have detergent residues on them.	Non-dissolving particles of some detergents may adhere to your laundries as white spots.	Perform an extra rinsing by setting your machine to "Rinsing" programme, or clean the spots using a brush after your laundries dries.
Grey spots appear on the laundries.	The reason for this spots may be oil, cream or ointment.	Apply the maximum amount of detergent instructed by the detergent manufacturer in the next washing operation.

(**) See the chapter regarding installation of your machine.

CHAPTER -10: TROUBLESHOOTING

FAULT	POSSIBLE CAUSE	REMOVING METHODS
Wringing operation is not performed or runs late.	No fault. Unbalanced load control system has been activated.	Unbalanced load control system will try to spread your laundries homogeneously. Wringing operation will start after spreading your laundries. Put your laundries in the machine homogeneously in the next washing operation.



CHAPTER -11: AUTOMATIC FAULT WARNINGS AND WHAT TO BE DONE

Your machine is equipped with the systems which are capable of both taking necessary precautions and warning you in case of any breakdown by means of continuous self-checking during washing operations.

TROUBLE CODE	POSSIBLE FAULT	WHAT TO DO
E01	The door of your machine is left open.	Close the machine door. If your machine persists to indicate fault, turn off your machine, unplug it and contact the nearest authorised service immediately.
E03	Pump is faulty or pump filter is clogged or electrical connection of the pump is faulty.	Clean the pump filter. If the problem persists, contact the nearest authorised service. (*)
E04	Your machine has excessive amount of water.	Your machine will discharge water by itself. Pursuant to discharging operation, turn off your machine and unplug it. Turn off your faucet and contact the nearest authorised service.

(*) See the chapter regarding maintenance and cleaning of your machine.

CHAPTER -11: AUTOMATIC FAULT WARNINGS AND WHAT TO BE DONE

TROUBLE CODE	POSSIBLE FAULT	WHAT TO DO
	<p>Water cut-off or low mains water pressure..</p>	<ul style="list-style-type: none"> - Water faucet may be closed. Check. - Mains water may be cut-off. Check. - If so, switch the programme knob to position 0. You can select a programme and run your machine after the mains water is supplied. - Mains water pressure may be low. Check. - Water inlet hose may be twisted. Check. - Water inlet hose may be clogged. - Clean water inlet hose filters. (*) - Valve inlet filter may be clogged. - Clean the valve inlet filters. (*) <p>If the problem persists, unplug your machine, turn off your faucet and contact the nearest authorised service.</p>
	<p>Pump is faulty or pump filter is clogged or electrical connection of the pump is faulty.</p>	<ul style="list-style-type: none"> - Pump filter may be clogged. Clean the pump filter. (*) - Discharging hose may be clogged or twisted. Check the discharging hose. <p>If the problem persists, contact the nearest authorised service. (*)</p>

CHAPTER -12: DESCRIBING SAVING ENERGY

Energy and water consumption may vary based on water pressure, water hardness, water temperature, ambient temperature, laundry amount, additional function selection, voltage fluctuations.

It will reduce energy and water consumption to use your machine with the laundry capacity proposed for the selected programme, wash your laundries less dirty or daily laundries in short programmes, carry out cleaning and maintenance periodically, use your machine in convenient time intervals specified by electricity vendor.

DISPOSAL OF YOUR OLD MACHINE



This symbol on the product or package implies that the product should not be treated as domestic waste. Instead, it should be delivered to applicable waste collection places recycling electrical and electronic equipment. You will contribute to avoid potential negative results regarding environment and human health, which will arise due to wrong waste procedure for the product by ensuring that this product is annihilated properly. Recycling materials will help natural resources be preserved. For more detailed information regarding recycling of this product, please contact local municipality, domestic waste annihilation service or the shop you have purchased the product.

CE